

VENSTAR®

COMMERCIAL
T4975-IAQ

DIGITAL THERMOSTAT



VENNet™
System Network

EXPLORER® IAQ

Up to 2 Heat & 4 Cool Stages
With Air Patrol, Humidity Control,
& Light Activation



Owner's Manual and
Installation Instructions



CAUTION

Follow the Installation Instructions before proceeding. Set the thermostat mode to “OFF” prior to changing settings in setup or restoring Factory Defaults.

This Explorer thermostat has the ability to receive updates to its firmware. Periodic firmware updates are released by the manufacturer to add features and/or performance enhancements. This manual was produced reflecting the most current firmware/feature set at the time of publication, firmware rev. 5.00. Firmware releases after rev. 5.00 may not be adequately depicted in this manual.

FCC Compliance Statement

This device complies with Part 15 of the FCC Rules. Operation is subject to the following two conditions:

- (1) this device may not cause harmful interference, and
- (2) this device must accept any interference received, including interference that may cause undesired operation.

Changes or modifications not expressly approved by Venstar could void the user's authority to operate the equipment.

This equipment has been tested and found to comply with the limits for a Class B digital device, pursuant to Part 15 of the FCC Rules. These limits are designed to provide reasonable protection against harmful interference in a residential installation. This equipment generates, uses and can radiate radio frequency energy and, if not installed and used in accordance with the instructions, may cause harmful interference to radio communications. However, there is no guarantee that interference will not occur in a particular installation. If this equipment does cause harmful interference to radio or television reception, which can be determined by turning the equipment off and on, the user is encouraged to try to correct the interference by one or more of the following measures:

- Reorient or relocate the receiving antenna.
- Increase the separation between the equipment and receiver.
- Connect the equipment into an outlet on a circuit different from that to which the receiver is connected.
- Consult the dealer or an experienced radio/TV technician for help

This device contains licence-exempt transmitter(s)/receiver(s) that comply with Innovation, Science and Economic

Development Canada's licence-exempt RSS(s). Operation is subject to the following two conditions:

1. This device may not cause interference.
2. This device must accept any interference, including interference that may cause undesired operation of the device.

L'émetteur/récepteur exempt de licence contenu dans le présent appareil est conforme aux CNR d'Innovation, Sciences et Développement économique Canada applicables aux appareils radio exempts de licence. L'exploitation est autorisée aux deux conditions suivantes :

1. *L'appareil ne doit pas produire de brouillage;*
2. *L'appareil doit accepter tout brouillage radioélectrique subi, même si le brouillage est susceptible d'en compromettre le fonctionnement*

FCC ID : MUH-SKYPOR14

IC: 12547A-SKYPOR14



Innovation, Science and Economic Development Canada
ICES-003 Compliance Label: CAN ICES-3 (B)/NM8-3(B)

Table of Contents

GLOSSARY OF TERMS	1
GET TO KNOW YOUR THERMOSTAT	2
HOW TO USE YOUR THERMOSTAT	7
Selecting the Heat or Cool Mode	7
Selecting your desired temperature	7
Using the Fan Button	7
Viewing Air Quality and Temperature Values.....	8
Using the Override Button	9
Viewing only connected wifi or VenNet sensor Values	9
Viewing and adjusting humidity values	9
Setting the Clock and Day	10
Turning the schedule ON/OFF	10
Programming a Schedule	10
AIR PATROL	12
VENNET SENSORS	15
Pairing a sensor.....	15
Un-pairing a sensor.....	16
Factory Defaulting a sensor.....	16
SETUP STEPS	
Program Mode (non-programmable or 7 day programmable)	17
Available Modes (heat only, cool only, heat/cool, auto)	17
Backlight (on/off, intensity, nighttime dimming)	18
View equipment runtimes (filter, heat, cool, aux heat, UV, humidifier)	18
Set / Reset Service Filter	18
Heating and Cooling System Runtime	19
Language (English, Spanish, French).....	20
Setpoint limits.....	21
*Equipment Timers and Heat/Cool spread	22
*Deadbands and Interstage Timers.....	23
*Minutes of Fan Purge.....	24

*Using a wired remote sensor.....	25
*Which sensor to use for temperature control.....	25
*Humidity settings	26
*Fan Off delay	26
Select Fahrenheit or Celsius	27
Smart Recovery.....	27
*Dry Contact Input (polarity, use)	28
*Humidify / Dehumidify Outputs	29
*Light Activation	29
*Automated Demand Response	30
Air Patrol (air quality range, fan runtime).....	32
*Skyport (on, off).....	32
*Local API (on,off).....	32
Show Clock.....	32
Show IAQ	32
Clear all messages	32
LOCKING/UNLOCKING THE BUTTONS	33
HOLIDAY.....	34
CALIBRATION	35
RESTORING FACTORY DEFAULT SETTINGS	36
TEST OUTPUTS AND CALIBRATE TEMPERATURE SENSOR	37
INSTALLATION INSTRUCTIONS.....	38
TECHNICIAN SETUP	44
TROUBLESHOOTING	45
ADVANCED SETUP TABLE	46
WARRANTY.....	49

*Some of the settings are usually adjusted by the installer. It is acceptable to have any of these steps be adjusted by the user as well. Contact Venstar if you have further questions on the meaning of these settings

Glossary of Terms

Air Patrol: Feature that turns on the fan when measured air quality is below what is desired.

Auto-Changeover: A mode in which the thermostat will turn on the heating or cooling based on room temperature demand.

Cool Setpoint: The warmest temperature that the space should rise to before cooling is turned on (without regard to deadband).

Deadband: The number of degrees the thermostat will wait, once a setpoint has been reached, before energizing heating or cooling.

Dehumidify: To reduce the amount of moisture in the air.

Differential: The forced temperature difference between the *heat setpoint* and the *cool setpoint*.

Heat Setpoint: The coolest temperature that the space should drop to before heating is turned on (without regard to deadband).

Humidify: To increase the amount of moisture in the air.

Icon: The word or symbol that appears on the thermostat display.

Mode: The current operating condition of the thermostat (i.e. Off, Heat, Cool, Auto).

Non-Programmable Thermostat: A thermostat that does not have the capability of running *Time Period Programming*.

Override: During programmed unoccupied periods, pressing the Override button will force the thermostat into occupied settings. During programmed occupied periods, pressing the Override button will force the thermostat into unoccupied settings.

Programmable Thermostat: A thermostat that has the capability of running *Time Period Programming*.

Reheat: Running the cooling and 2nd stage strip heaters at the same time in order to *dehumidify* the air without significantly cooling down the room temperature.

Temperature Swing: *Same as Deadband.*

Time Period Programming: A program that allows the thermostat to automatically adjust the *heat setpoint* and/or the *cool setpoint* based on the time of the day.

Get To Know Your Thermostat

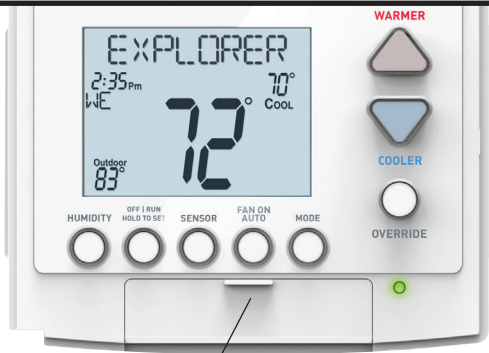
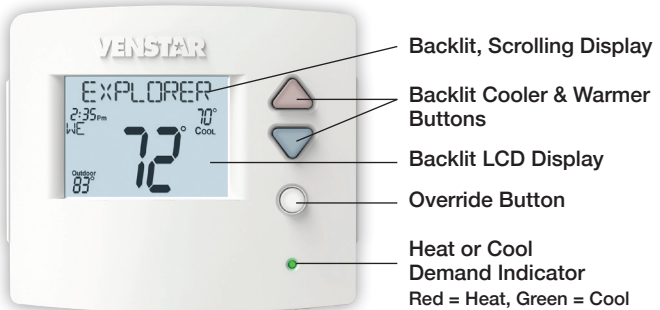

Setup Buttons Behind Door

Get To Know Your Thermostat

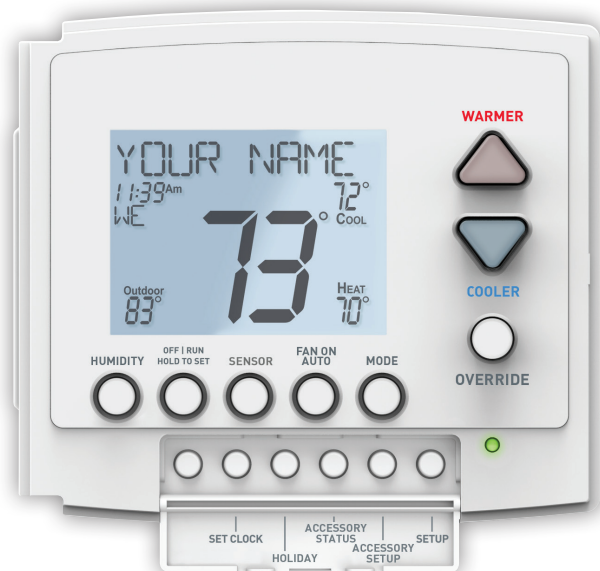

Setup Buttons

Get To Know Your Thermostat

Display Features

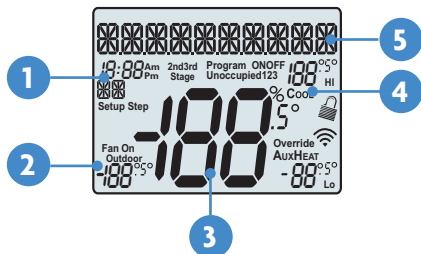

Note : You may see 2nd/3rd illuminated even though you don't have actual multistage equipment. This has NO EFFECT on your primary heating or cooling - it will run whether or not you see 2nd/3rd on the display

- 1 Clock with Day of the Week**—Indicates the current time and day. This clock is also used to program the time period schedules.
- 2 Outdoor icon**—Indicates the temperature displayed is from the optional outdoor sensor or public weather from Skyport.
- 3 Room Temperature Display**—Indicates the **current** room temperature and displays the outdoor temperature when selected.
- 4 Mode Indicators**
Selects the operational mode of the equipment.
 - HEAT** - Indicates the heating mode.
 - COOL** - Indicates the air conditioning mode.*
 - HEAT & COOL** - Indicates the system will automatically change-over between heat and cool modes as the temperature varies.
 - OFF** - Indicates heating and cooling are turned off.
- 5** The scrolling display will be used to help you easily navigate the setup screens in the thermostat.

* **COOL** will blink when cooling is running for dehumidification

Get To Know Your Thermostat

Display Features

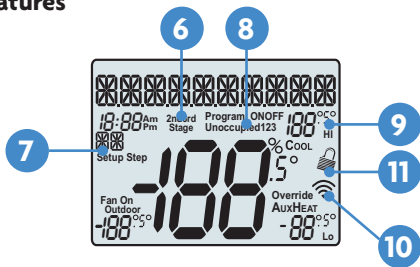

- 6 2nd and 3rd Stage icons**
Indicates what stage of cooling or heating is currently energized.
Note: '3rd' and 'COOL' will both blink when the 4th stage of cooling is active.
- 7 Setup Step icon**
Indicates the step number when in advanced setup.
- 8 Occupied & Unoccupied icons**
Indicates the program number: Occupied 1, 2, 3 or Unoccupied
- 9 Desired Set Temperature**
Indicates **desired** room temperature(s). Also displays the highest and lowest temperatures for the day.
- 10 Wi-Fi icons**
One dot will always be present and the full wifi icon will appear when connected to the local access point. The dot will blink when the thermostat is reaching the skyport server.
- 11 icon**
Press MODE, WARMER and COOLER buttons together to toggle the keylock.

Get To Know Your Thermostat

Display Features

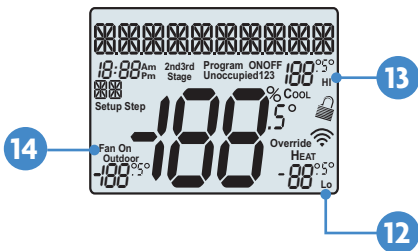

- 12 Lo icon**
Indicates the lowest recorded outdoor temperature for the day.*
- 13 Hi icon**
Indicates the highest recorded outdoor temperature for the day.*
- 14 Fan On icon**
Indicates constant, continuous fan operation.
When **Fan On** is not lit - indicates the fan will only operate when necessary to heat or to cool.

* *Hi and Lo Temperatures for the day, reset at midnight.*

How to use your thermostat

During Setup and Programming

Press the **WARMER** or **COOLER** buttons to modify the selection.

Press the **MODE** button to advance and confirm through the setup steps.

Selecting the Heat or Cool Mode

Select mode by pressing the MODE button.

HEAT - Only the heating operation will be controlled by the thermostat in this mode.

COOL - Only the cooling operation will be controlled by the thermostat in this mode.

AUTO - Auto-Changeover will automatically select heat or cool based on room temperature demand.

OFF - OFF indicates both heating and air conditioning systems are turned off.

Selecting your desired temperature

HEAT OR COOL MODE - Pressing the **WARMER** or **COOLER** buttons in Heat or Cool mode will adjust only the heat or cool setpoints individually displayed.

AUTO-CHANGEOVER MODE - Pressing the **WARMER** or **COOLER** buttons in Auto mode will adjust both the heat and cool setpoints simultaneously. To adjust heat and cool setpoints individually, choose **HEAT** mode to adjust the heat setpoint and **COOL** mode to adjust the cool setpoint, then return to **AUTO** mode.

Using the Fan Button

FAN ON indicates constant fan operation. **FAN ON** is not allowed when the thermostat is in the **OFF** mode. Pressing the **FAN** button toggles this feature. If you don't see **FAN ON**, the fan is in auto mode and will only turn on during a heat or cool demand. The fan is forced into auto mode when running the program and the thermostat shows "unoccupied". If **FAN ON** is blinking, the fan is running because of Air Patrol. The **FAN** button does not have any effect when **FAN ON** is blinking.

FAN ON
AUTO



How to use your thermostat

Viewing Air Quality and Temperature Values

Press the SENSOR button to view the internal sensors and any optional remote sensors. The screens may appear as follows. Press MODE to advance to the next sensor, press SENSORS to exit this function.

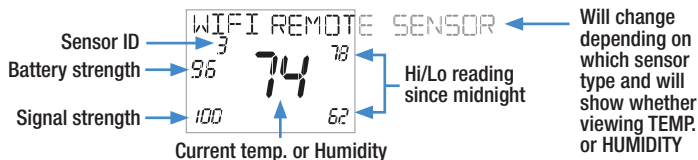
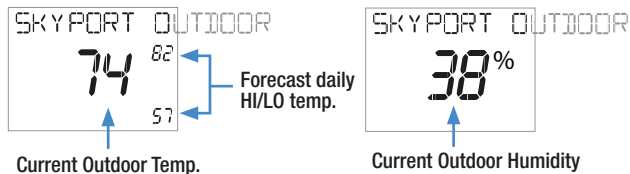
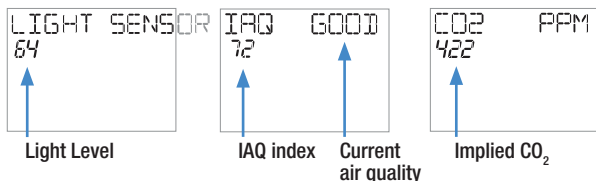

Descriptions of the IAQ readings are discussed further in the Air Patrol section on page 12. Any values that are invalid or unavailable will appear as dashes.

How to use your thermostat

Using the Override Button

UNOCCUPIED OPERATION -

During programmed, unoccupied periods, pressing the OVERRIDE button will force the thermostat into Occupied 1 settings for 30 minutes. Each press of the OVERRIDE button will add another 30 minutes of time for up to 4 hours. If the maximum time has been set, the next press of the OVERRIDE button will reset the timer and return the thermostat to the correct time period program for the day

OCCUPIED OPERATION - During programmed, occupied periods, pressing the OVERRIDE button will force the thermostat into an unoccupied period for the rest of the day. During this forced unoccupied period the OVERRIDE button will operate as described above.



OVERRIDE

NOTE: Override may only be used when the thermostat is set to PROGRAM ON.

Viewing only connected wifi or VenNet Sensor Values

You may also view connected wifi and VenNet sensor values after pressing ACCESSORY STATUS followed by COOLER button. Use MODE button to cycle between readings. Note that battery strength of the battery powered sensors can be viewed on these screens. Press ACCESSORY STATUS again to return to normal operation.

Viewing and adjusting Humidity Values

Press the HUMIDITY button. The current indoor relative humidity and daily min/max values are shown. If you wish to alter either the humidification or dehumidification setpoints, press MODE to cycle between screens and WARMER/COOLER to adjust the settings. Press HUMIDITY again to return to normal operation.

How to use your thermostat

Setting the Clock and Day

Not available when connected to the Skyport server

Press the SET CLOCK button. Adjust the clock using the WARMER or COOLER buttons. Press MODE to advance to the day setting. Adjust the day using the WARMER or COOLER buttons. Press the SET CLOCK button to confirm settings.

TIP: To adjust the time by hours press and hold the FAN button while pressing the WARMER or COOLER buttons.



Turning the schedule ON/OFF

Press/release **OFF | RUN HOLD TO SET** to change between **PROGRAM ON** and **PROG OFF**.



If you are unable to select **PROGRAM ON**, setup step #1 is most likely set for **NON-PROGRAM** (non-programmable).

Programming a Schedule

Press/hold **OFF | RUN HOLD TO SET** until you see **SET PROGRAM**, followed by some brief instructions.

Press the **MODE** button to start entering a schedule.

Press the **WARMER** or **COOLER** buttons to make changes.

Press the **MODE** button to advance to the next step.

How to use your thermostat

Programming a Daily Schedule

Once the Set Program prompt appears the Mode button will step you through the settings. When selecting a Mode for Unoccupied/Occupied, options are OFF, HEAT, COOL, HEAT and COOL. These may be limited by the selection in setup step #2, AVAILABLE MODES.

Set the Unoccupied Mode – Press the Warmer or Cooler buttons to choose the mode for the Unoccupied period. The thermostat is in Unoccupied when the Time Period Schedule is running and there is not an active Occupied period.

Adjust the Unoccupied Cool Setpoint – Press the Warmer or Cooler buttons to adjust the Cooling setpoint for times when the thermostat is in Unoccupied.

Adjust the Unoccupied Heat Setpoint – Press the Warmer or Cooler buttons to adjust the Heating setpoint for times when the thermostat is in Unoccupied.

Select the number of Occupied time periods – Press the Warmer or Cooler buttons to choose the maximum number (up to 3 maximum) of Occupied time periods in a day.

Select the Mode for the Occupied period – Press the Warmer or Cooler buttons to choose the mode for the occupied period.

Adjust the Occupied Cool Setpoint – Press the Warmer or Cooler buttons to adjust the Cooling setpoint for comfort.

Adjust the Occupied Heat Setpoint – Press the Warmer or Cooler buttons to adjust the Heating setpoint for comfort.

The following steps determine when the Occupied period(s) will be active.

Enable Occupied 1 – Press the Warmer or Cooler buttons to enable (On) or to disable (Off) Occupied 1 on Monday.

Adjust the Start Time for Occupied 1 – Press the Warmer or Cooler buttons to adjust the start time for Occupied 1 on Monday.

Adjust the Stop Time for Occupied 1 – Press the Warmer or Cooler buttons to adjust the stop time for Occupied 1 on Monday.

Upon pressing Mode after the above step; you will be prompted to Save and Exit or Copy this Occupied schedule to another day.

To save and exit – Press the Program button.

To Copy Monday's settings/schedule to Tuesday – Press Up and then Mode. Press Mode again to copy the Monday Settings/schedule to subsequent days.

To Program Another Day – Press Down and then press the Mode button to select the day to program. Repeat the above steps for each day you would like to program.

Press the OFF | RUN HOLD TO SET button to exit Time Period Programming at any time.

OFF | RUN
HOLD TO SET



Air Patrol

Air Patrol continually samples the Indoor Air Quality (IAQ) at the thermostat. When Air Patrol is enabled and the Indoor Air Quality drops into the selected category:

- The fan will turn on to circulate the air through the HVAC's filtration system with a 5 minute minimum runtime
- The fan will continue to operate until:
 - The Indoor Air Quality improves, OR
 - The fan runtime reaches its selected maximum runtime per hour, the Air Patrol Duration
- Additionally, the thermostat's AUX output can be asserted to control 3rd party devices such as ionizers or extra filtration*

The values for Indoor Air Quality categories are:

IAQ Index	Air Quality	Suggested Action
0 - 50	Excellent	
51 - 100	Good	
101 - 250	Moderate	Ventilation suggested
> 250	Poor	Increase ventilation with clean air

Air Patrol

Setup & Configuration

Air Patrol is configured from Skyweb, Venstar's Skyport web application.

Select an Explorer-IAQ thermostat to configure the Air Patrol settings.

- 1 Select the "3 vertical dots" in the top right corner.
- 2 Select "Settings" at the bottom of the drop-down menu.

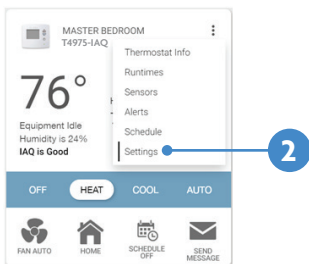
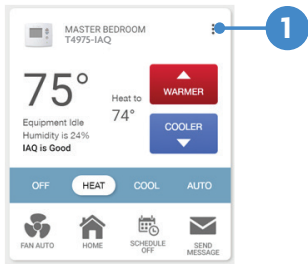

- 3 Select "Indoor Air Quality" in the shaded area of Settings.

Indoor Air Quality

Current Indoor Air Quality: 51 - **Good**

Enable Air Patrol:

Air Patrol Threshold:
 Moderate - Greater than 100
 Poor - Greater than 250

Air Patrol Duration: 10 mins / hr

Air Patrol continually samples the Indoor Air Quality (IAQ) at this thermostat.
When Air Patrol is enabled and the Indoor Air Quality drops into the selected category:

- The fan will turn on to circulate the air through the HVAC's filtration system with a 5 minute minimum runtime.
- The fan will continue to operate until:
 - The Indoor Air Quality improves, or
 - The fan runtime reaches its selected Air Patrol Duration, maximum runtime per hour
- The values for Indoor Air Quality categories are:

IAQ Index	Air Quality	Suggested Action
0 - 50	Excellent	
51 - 100	Good	
101 - 250	Moderate	Ventilation suggested
> 250	Poor	Increase ventilation with clean air

Notes from the IAQ sensor's manufacturer: The sensor does not directly measure CO2, but derives it from the correlation between breath VOCs and CO2 in human's exhaled breath.

Cancel

Air Patrol

- 4 Enable Air Patrol. When enabled the Air Patrol Threshold and Duration settings will appear.
- 5 Set the Air Patrol Threshold at which Air Patrol will turn on on the HVAC fan/filtration and assert an auxiliary output.
- 6 Set the Air Patrol Duration. This is the maximum the fan is allowed to run per hour. If the Air Quality does not reach the next better IAQ level in this allotted time, it will stop the fan and resume next hour. If it is set to 60 minutes per hour, the fan will continue to run until the IAQ level reaches the next level above the selected threshold.
- 7 Send this Air Patrol configuration to the thermostat.

MASTER BEDROOM Settings

Thermostat Info

Indoor Air Quality

Current Indoor Air Quality 51 - Good

Enable Air Patrol

Air Patrol Threshold

Moderate - Greater than 100

Poor - Greater than 250

Air Patrol Duration - 10 mins / hr +

Air Patrol continually samples the Indoor Air Quality (IAQ) at the thermostat.

When Air Patrol is enabled and the Indoor Air Quality drops into the selected category:

- The fan will turn on to circulate the air through the HVAC's filtration system with a 5 minute minimum runtime
- The fan will continue to operate until:
 - The Indoor Air Quality improves, or
 - The fan runtime reaches its selected Air Patrol Duration, maximum runtime per hour
- The values for Indoor Air Quality categories are:

IAQ Index	Air Quality	Suggested Action
0 - 50	Excellent	
51 - 100	Good	
101 - 250	Moderate	Ventilation suggested
> 250	Poor	Increase ventilation with clean air

Notes from the IAQ sensor's manufacturer: The sensor does not directly measure CO2, but derives it from the correlation between breath VOCs and CO2 in human's exhaled breath.

Cancel Send to Thermostat

Pairing a Sensor

1. Press and hold the PAIR button on the sensor for 1 second.

- Upon release of the PAIR button, the LED will flash twice.
- The sensor will remain in its pairing state for 1 minute.

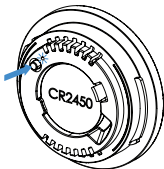

2. Move the sensor to within 3 inches of the thermostat.

3. The thermostat will recognize the sensor and display NEW SENSOR IS DETECTED.

Press WARMER to pair the sensor to the thermostat.

- The thermostat will display PAIRING.
- Pressing COOLER will remove the message from the display and stop the pairing procedure on the thermostat.

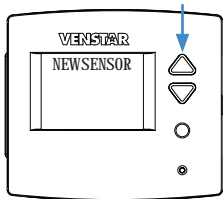

4. Once pairing is completed, you must select the type of sensor, Remote or Outdoor.

- At this point, the thermostat will display REMOTE SENSORTYPE, press WARMER or COOLER to change, press MODE to accept.
 - Pressing WARMER or COOLER will allow you to choose REMOTE SENSOR or OUTDOOR SENSOR.
 - Press FAN to accept the type of sensor chosen.
 - The thermostat will display SENSOR # IS PAIRED twice and return to the Home Screen.

5. If set as REMOTE and you wish to use the sensor for temperature control, alter setup steps 40 and 41 as necessary.

6. You may use Skyport to assign a logical name to the sensor.

VenNet Sensors

Un-Pairing any wireless Sensor

1. Press the ACCESSORY STATUS button
2. Press the COOLER button to view all wireless sensors, either VenNet or wifi sensors will be shown.
3. Press WARMER/COOLER buttons to select the sensor to be un-paired
4. Press/hold FAN button for 2 seconds
5. Press WARMER button to un-pair the VenNet/Wifi sensor or press COOLER button to make no changes
6. Press the ACCESSORY STATUS button to return to normal operation
7. You may use Skyport to assign a logical name to the sensor. It is advisable to name the sensor before pairing additional sensors

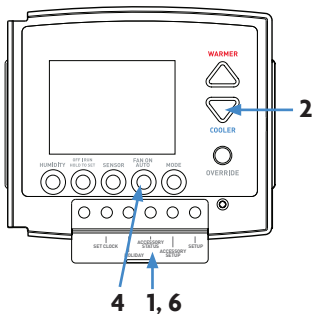

Returning a Sensor to Factory Default settings

If you are pairing the sensor to a new thermostat, you will need to remove the previously paired thermostat from the sensor's memory. You can use the unpairing process above, or you may find it easier to simply clear the sensor's memory and bring it back to factory default settings.

To do so:

1. Press and hold the sensor's PAIR button for up to 5 seconds.
2. Once the sensor has been erased, the sensor's LED will flash twice and return to pairing mode.
3. If not paired to a thermostat within 1 minute, the sensor will return to sleep mode.

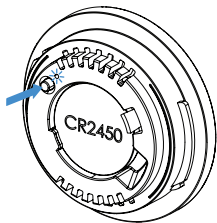

Setup Steps

How to Change Settings in the Setup Screens

To enter Advanced Setup, press the **SETUP** button, then press **MODE**. Use the **WARMER** or **COOLER** buttons to adjust the value of your selection. Press **MODE** to advance to the next setup step. Press **SETUP** again to leave the setup screens.



*Some of the following settings are usually adjusted by the installer. It is acceptable to have any of these steps be adjusted by the user as well. Contact Venstar if you have further questions on the meaning of these settings

Program Mode (Setup Step 1)

This thermostat may be configured to be programmable or non programmable.

7 Day Program - Allows all seven days to be programmed independently.

Non Program - No advanced time period programming available.

Selecting Your Available Modes (Setup Step 2)

Auto-Changeover - Allows the thermostat to turn on heating or cooling based on room temperature demand. Also allows the manual selection of **HEAT** only or **COOL** only and **OFF**.

Heat and Cool - Allows the thermostat to turn on heating or cooling depending on which one has been manually selected. Auto-Changeover is not available when this is selected.

Heat Only - Allows the thermostat to only turn on **HEAT** or **OFF** modes.

Cool Only - Allows the thermostat to only turn on **COOL** or **OFF** modes.

Setup Steps

Press the **SETUP** button, then press **MODE** repeatedly until the desired setup step appears. Use the **WARMER** or **COOLER** buttons to make selection. Press **MODE** to advance to the next step. Press/hold **MODE** to go backwards to prior steps. Press **SETUP** to leave the setup screens.



Backlight (Setup Steps 3-8)

Backlight (Setup Step 3)

Off - Backlight turns on with any button press and turns off after 8 seconds.

On - Backlight is on continuously.

Backlight Intensity Level (Setup Step 4)

The backlight can be adjusted between Off and seven levels of brightness.

Night Dimmer (Setup Step 5)

Selecting **On** allows for automatic dimming of the display at night.

Night Dimmer Brightness (Setup Step 6)

Off through seven levels of brightness

Night Dimmer Start Time (Setup Step 7)

12:00 am to 12:00 am

Night Dimmer Stop Time (Setup Step 8)

12:00 am to 12:00 am

Resetting Service Filter (Setup Steps 9, 10)

These will show how long your fan has been running in hours and days. View both of these steps and press **FAN** while viewing to reset the counter to 0. This should clear the **SERVICE FILTER** message.

Current Service Filter Runtime Hours (Setup Step 9)

This counter keeps track of the number of hours of fan runtime in the Heating mode, Cooling mode, and in stand alone Fan operation. Press **FAN** to reset.

Current Service Filter Calendar Days (Setup Step 10)

This counter displays the total number of calendar days that have elapsed since the counter was reset to help the user track Fan runtime. Press **FAN** to reset.

Setup Steps

Press the **SETUP** button, then press **MODE** repeatedly until the desired setup step appears. Use the **WARMER** or **COOLER** buttons to make selection. Press **MODE** to advance to the next step. Press/hold **MODE** to go backwards to prior steps. Press **SETUP** to leave the setup screens.



Heating and Cooling System Runtime - (Setup Steps 11-15)

Current Heat Runtime Hours (Setup Step 11)

This counter keeps track of the number of hours the system has run in Heating. Press **FAN** to reset.

Current Aux Strip Heat Runtime Hours (Setup Step 12)

This counter keeps track of the number of hours the system has run in Auxiliary Heating. This setup step is only available when the thermostat jumpers are configured for Heat Pump and Electric Heat. Press **FAN** to reset.

Current Cool Runtime Hours (Setup Step 13)

This counter displays the number of hours the system has run in Cooling. Press **FAN** to reset.

Current Override Hours (Setup Step 14)

This counter keeps track of the number of hours that the thermostat is overridden into Occupied settings. Press **FAN** to reset.

Current UV Lamp Calendar Days (Setup Step 15)

This counter displays the total number of calendar days that have elapsed to help the user track UV lamp runtime. Press **FAN** to reset.

Current Humidifier Calendar Days (Setup Step 16)

This counter displays the total number of calendar days that have elapsed to help the user track the Humidifier run-time. Press **FAN** to reset.

Setup Steps

Press the **SETUP** button, then press **MODE** repeatedly until the desired setup step appears. Use the **WARMER** or **COOLER** buttons to make selection. Press **MODE** to advance to the next step. Press/hold **MODE** to go backwards to prior steps. Press **SETUP** to leave the setup screens.



These setup steps allow the user to monitor equipment runtimes and program service alerts. Service alerts are displayed in the scrolling marquee.

FAN ON
AUTO



Press and hold **FAN** to clear service alert messages from the scrolling marquee.

Runtime hours or days appear in the clock display.



Service Filter Runtime (Setup Steps 17-18)

Set Service Filter Runtime Hours (Setup Step 17) -

This timer allows the user to specify the number of hours the fan will run before the "Replace Filter" alert will be displayed. Press **COOLER** continuously until **OFF** is displayed to disable this alert.

Set Service Filter Calendar Days (Setup Step 18) -

This timer allows the user to specify the number of calendar days that will elapse before the "Replace Filter" alert will be displayed. Press **COOLER** continuously until **OFF** is displayed to disable this feature.

UV Lamp Runtime (Setup Step 19)

Set UV Lamp Calendar Days (Setup Step 19) - This timer allows the user to specify the number of calendar days the UV Lamp will operate before the "Replace UV Lamp" alert will be displayed. Press **COOLER** continuously until **OFF** appears to disable this alert.

Humidifier Runtime (Setup Step 20)

Set Humidifier Calendar Days (Setup Step 20) - This timer allows the user to specify the number of calendar days the Humidifier will run before the "Service Humidifier" alert will be displayed. Press **COOLER** continuously until **OFF** appears to disable this alert.

Language (Setup Step 21)

Setup step instructions on the scrolling display can be set for English, Spanish, or French.

Setup Steps

Press the **SETUP** button, then press **MODE** repeatedly until the desired setup step appears. Use the **WARMER** or **COOLER** buttons to make selection. Press **MODE** to advance to the next step. Press/hold **MODE** to go backwards to prior steps. Press **SETUP** to leave the setup screens.



Setpoint Limits (Setup Step 22)

When this feature is set to ON, the heat and cool setpoints can be restricted to preset levels, set in steps 23 and 24.

Maximum Heat Setpoint (Setup Step 23)

(35° - 99°).

Minimum Cool Setpoint (Setup Step 24)

(35° - 99°).

Setup Steps

Press the **SETUP** button, then press **MODE** repeatedly until the desired setup step appears. Use the **WARMER** or **COOLER** buttons to make selection. Press **MODE** to advance to the next step. Press/hold **MODE** to go backwards to prior steps. Press **SETUP** to leave the setup screens.



Cycles Per Hour* (Setup Step 25)

The Cycles Per Hour setting may limit the number of times per hour your HVAC unit may energize. For example, at a setting of 6 cycles per hour the HVAC unit will only be allowed to energize once every 10 minutes. The Cycles Per Hour limit may be overridden and reset by pressing the **WARMER** or **COOLER** buttons on the thermostat. Settings are No Limit, 2, 3, 4, 5, or 6.

Compressor Minimum Off Minutes* (Setup Step 26)

This feature allows the user to set a minimum off time for the compressor. Settings are 5 mins., 3 mins., or 0 mins.

Minimum Heat/Cool Setpoint Difference* (Setup Step 27)

This feature allows the user to set the minimum gap between Heat and Cool setpoints in **AUTO** mode. Select from 0 to 6. If setup step 2 is not set for **AUTO-CHANGEOVER**, this step will not appear.

*Some of the following settings are usually adjusted by the installer. It is acceptable to have any of these steps be adjusted by the user as well. Contact Venstar if you have further questions on the meaning of these settings

Setup Steps

Press the **SETUP** button, then press **MODE** repeatedly until the desired setup step appears. Use the **WARMER** or **COOLER** buttons to make selection. Press **MODE** to advance to the next step. Press/hold **MODE** to go backwards to prior steps. Press **SETUP** to leave the setup screens.



Deadband Settings* (Setup Steps 28 - 34)

The Deadband is the number of degrees or minutes that the thermostat waits before it initiates the stages of heating or cooling.

1st Stage Deadband (Setup Step 28) - Specifies the minimum temperature difference between the room temperature and the desired setpoint before the first stage of heating or cooling is allowed to turn on. (1 - 6 degrees) For example, if the heat setpoint is 68° and the 1st Stage deadband is set to 2 degrees, the room temperature will need to reach 66° before the heat turns on.

2nd Stage Deadband (Setup Step 29) - Specifies the additional minimum temperature difference after the first stage turns on before the second stage is activated. (0° - 10°)

3rd Stage Deadband (Setup Step 30) - Specifies the additional minimum temperature difference after the second stage turns on before the third stage of cooling is activated. (0° - 10°)

4th Stage Deadband (Setup Step 31) - Specifies the additional minimum temperature difference after the third stage turns on before the final stage of cooling is activated. (0° - 10°)

Minutes Between 1st and 2nd Stage (Setup Step 32) - Specifies the **minimum** time (in minutes) after the first stage must run before the second stage can turn on.

Minutes Between 2nd and 3rd Stage (Setup Step 33) - Specifies the **minimum** time (in minutes) after the second stage must run before the third stage can turn on.

Minutes Between 3rd and 4th Stage (Setup Step 34) - Specifies the **minimum** time (in minutes) after the third stage must run before the final stage can turn on.

*Some of the following settings are usually adjusted by the installer. It is acceptable to have any of these steps be adjusted by the user as well. Contact Venstar if you have further questions on the meaning of these settings

Setup Steps

Press the SETUP button, then press MODE repeatedly until the desired setup step appears. Use the WARMER or COOLER buttons to make selection. Press MODE to advance to the next step. Press/hold MODE to go backwards to prior steps. Press SETUP to leave the setup screens.



Second Stage Turnoff Point (Setup Step 35) - Specifies whether second stage will turn off at first stage deadband or remain on until the room temperature demand is satisfied. Choose between Deadband or Setpoint.

Third Stage Turnoff Point (Setup Step 36) - Specifies whether third stage of cooling will turn off at second stage deadband or remain on until the room temperature demand is satisfied. Choose between Deadband or Setpoint.

Fourth Stage Turnoff Point (Setup Step 37) - Specifies whether fourth stage of cooling will turn off at third stage deadband or remain on until the room temperature demand is satisfied. Choose between Deadband or Setpoint.

Minutes of Fan Purge* (setup step 38)

When this feature is activated, the fan will turn on during an unoccupied period at a preset amount of time prior to Occupied 1. This preoccupancy fan purge timer may be set from zero to three hours, in 15 minute increments. Zero means this feature is turned off.

Setup Steps

Press the SETUP button, then press MODE repeatedly until the desired setup step appears. Use the WARMER or COOLER buttons to make selection. Press MODE to advance to the next step. Press/hold MODE to go backwards to prior steps. Press SETUP to leave the setup screens.



Wired Sensor Type* (Setup Step 39)

Specifies the use of the connected, wired sensor. The choices are: Remote, Supply, Outdoor. Only the remote option allows control of the sensor.

Control to Temp Source* (Setup Step 40)

This feature allows the user to specify which temperature sensor source the thermostat will use to measure room temperature.

Thermostat: uses the internal thermostat sensor only.

Wired Remote: uses the attached wired remote sensors.*

Wireless Remote: uses WiFi or VenNet sensor specified in step #41.

Average of Wireless Remotes: combines and averages all paired WiFi or VenNet sensors.

Average of Thermostat and Wired Remote: averages internal and attached wired remote sensor*.

Average all Sensors: averages internal, any attached wired or paired wireless sensors.

* These options only appear if step #39 (Wired Sensor Type) set to “remote”

NOTE: If a remote sensor is being used, the degree icon on the large room temperature display will blink.

Wireless Remote to Use* (Setup Step 41)

Specifies which paired WiFi or VenNet sensor to use for temperature control. This step only appears if step #40 (Control to Temp Source) set to “Wireless Remote”.

Setup Steps

Press the **SETUP** button, then press **MODE** repeatedly until the desired setup step appears. Use the **WARMER** or **COOLER** buttons to make selection. Press **MODE** to advance to the next step. Press/hold **MODE** to go backwards to prior steps. Press **SETUP** to leave the setup screens.



Humidity and Dehumidity* (Setup Steps 42-47)

Humidity Only With Heat (Setup Step 42)

When this step is set to ON, Humidity will not run without a demand for Heat.

Fan With Humidify (Setup Step 43)

Specifies if the fan should be turned on with a demand for Humidity.

Fan with Dehumidify (Set up Step 44)

Specifies if the fan should be turned on with a demand for Dehumidify.

(Note : this step might not appear unless Air Patrol is turned off in step 66).

Cool To Dehumidify (Setup Step 45)

Specifies if the cooling equipment is allowed to turn on exclusively to lower room humidity. (If set to **OFF** the following two steps will not appear.)

Max Occ. Dehum Overcool (Setup Step 46)

Specifies how many degrees below the Cool setpoint the air conditioning will run to satisfy a Cool to Dehumidify demand. (0° - 20°)

Max Unocc. Dehum Overcool (Setup Step 47)

Specifies how many degrees below the Cool setpoint the air conditioning will run to satisfy a Cool to Dehumidify demand. (0° - 20°)

Fan Off Delay in Seconds* (Setup step 48)

This feature allows the user to increase the cooling or electric strip heating efficiency of the system. The thermostat may be programmed to continue running the fan after a call for cooling or electric strip heating has been satisfied. This delay can be set for 0, 30, 60, 90, or 120 seconds. If set to 0, the fan will not run after a call for cooling or electric strip heating has been satisfied.

Setup Steps

Press the **SETUP** button, then press **MODE** repeatedly until the desired setup step appears. Use the **WARMER** or **COOLER** buttons to make selection. Press **MODE** to advance to the next step. Press **MODE** to go backwards to prior steps. Press **SETUP** to leave the setup screens.



Fahrenheit or Celsius (Setup Step 49)

This feature allows the thermostat to display temperature in Fahrenheit or Celsius.

Smart Recovery (Setup Step 50)

With Smart Recovery on, the thermostat will attempt to reach the Occupied 1 setpoint temperature at the exact time programmed into the thermostat.

Smart Recovery only works when the thermostat enters the Occupied mode from the Unoccupied mode. For example, if the Occupied program is set for 6am at 72°F heating and 75°F cooling, the thermostat will turn the system on before 6am in an effort to bring the temperature to its correct setting at exactly 6am. The thermostat learns from experience, so please allow 4 - 8 days after a program change or after initial installation to give Smart Recovery time to adjust.

Setup Steps

Press the **SETUP** button, then press **MODE** repeatedly until the desired setup step appears. Use the **WARMER** or **COOLER** buttons to make selection. Press **MODE** to advance to the next step. Press/hold **MODE** to go backwards to prior steps. Press **SETUP** to leave the setup screens.



Dry Contact Operation* (Setup Steps 51-52)

Dry Contact Polarity (setup Step 51)

Open (Normally Open) - The dry contact is open until the connected device closes the circuit.



'Idle'



'Active'

Closed (Normally Closed) - The dry contact is closed until the connected device opens the circuit.



'Idle'



'Active'

Dry Contact Use (Setup Step 52)

CONDENSATE - If **CONDENSATE** is selected when the dry contact is active, the thermostat will lockout the compressor terminal(s) and “**CONDENSATE PAN OVERFLOW**” will appear on the display.

OCCUPIED - If **OCCUPIED** is selected, when the dry contact is active, the thermostat will be forced into the programmed occupied mode / setpoints and the ‘occupied’ icon will blink. This setting is useful for allowing a twist timer to force occupied settings.

FDD - If **FDD** is selected when the dry contact is active, “**EQUIPMENT FAULT**” will appear on the display.

HOLIDAY - If **HOLIDAY** is selected, when the dry contact is active, the thermostat will be forced into the programmed unoccupied mode / setpoints and the ‘unoccupied’ icon will blink.

DOOR SWITCH - If **DOORSWITCH** is selected, when the dry contact is active for more than 3 minutes, the thermostat set points will switch to **OF** (off), the equipment will turn off, and **DOOR OPEN** will appear on the display.

Setup Steps

Press the **SETUP** button, then press **MODE** repeatedly until the desired setup step appears. Use the **WARMER** or **COOLER** buttons to make selection. Press **MODE** to advance to the next step. Press/hold **MODE** to go backwards to prior steps. Press **SETUP** to leave the setup screens.



Humidity Output Polarity* (Setup Step 53)

Open (Normally Open) means no voltage is sent to the **HUM** output when there is no demand for humidity.

Closed (Normally Closed) means voltage is sent to the **HUM** output when there is no demand for humidity.

Dehumidify Output Polarity* (Setup Step 54)

Open (Normally Open) means no voltage is sent to the **DEHUM** output when there is no demand to dehumidify.

Closed (Normally Closed) means voltage is sent to the **DEHUM** output when there is no demand to dehumidify.

Dehumidify Only With Cooling (Setup Step 55)

When set to **ON**, Dehumidify will only turn on with a 1st stage cooling demand.

When set to **OFF**, Dehumidify will turn on at any time that the room humidity exceeds the dehumidification setpoint.

Light Activation Sensitivity (Setup Step 56)

With the lights on in the space, press the **FAN** button to set the sensitivity of the light sensor. This light level will be the minimum light level needed to bring in occupied setpoints. When adjusting the sensitivity, the prior setting (0-199) will show in the clock display and the current light level (0-199) will show as the cool setpoint. Press **FAN** to store the present light level and press **MODE** to move to the next step.

Note: *The Skyport web app can track "lights on" runtime. This is accomplished by accumulating the hours that the light sensor of the thermostat recognizes that the lights are on.*

To use this feature of Skyport, adjust the light activation sensitivity.

Step 57 below does not need to be On for Skyport to accumulate "lights on" runtime.

Light Activation to Occupied (Setup Step 57)

This feature allows the thermostat to go from Occupied settings to Unoccupied settings when the room lights are turned off and the program is unoccupied. It also allows the thermostat to return to the Occupied 1 settings once the lights come back on.

OFF = Light Activation not used. **ON** = Light Activation is used.

Setup Steps

Press the **SETUP** button, then press **MODE** repeatedly until the desired setup step appears. Use the **WARMER** or **COOLER** buttons to make selection. Press **MODE** to advance to the next step. Press/hold **MODE** to go backwards to prior steps. Press **SETUP** to leave the setup screens.



ADR* (Setup Step 58)

Controls whether you want the thermostat to possibly respond to signals from the utility provider. Select **ON** to allow this and to have steps 59-65 appear. For these steps to have effect, your utility provider must have an applicable program in your service area in which Skyport participates and your thermostat is enrolled in the program. Check with your provider for enrollment details.

ADR Action* (Setup Step 59)

Observe Setpoint Offsets – will offset the heat and cool setpoints by the amounts specified in setup steps 64 and 65.

Observe Static Setpoints – will set the heat and cool setpoints to the values specified in setup steps 62 and 63.

DISPLAY INDICATIONS WHEN AN ADR EVENT IS HAPPENING

After setting your desired values for use during an ADR event, the scrolling display will give a little information when an event is pending or active. For instance, when an ADR event has been sent to your thermostat, you might see **ADR STARTS** at 4:15 to notify you of a pending event. Once active, you might see **ADR STOPS** at 5:30. If you have configured a threshold for cost of energy past which you want to trigger an event, you will see **PRICING EVENT** on the display. When an event is active, you can press any of **COOLER**, **WARMER** or **MODE** buttons, followed by the **WARMER** to opt out of the event.

Setup Steps

Press the **SETUP** button, then press **MODE** repeatedly until the desired setup step appears. Use the **WARMER** or **COOLER** buttons to make selection. Press **MODE** to advance to the next step. Press/hold **MODE** to go backwards to prior steps. Press **SETUP** to leave the setup screens.



Event Max Cool Setpoint* (Setup Step 60)

Event Min Heat Setpoint* (Setup Step 61)

Specifies the range of allowable setpoint adjustments to be enforced when any ADR signal has been received from the utility. Since you might be paying more for energy while an event is active, you can impose tighter limits on setpoint ranges that are only enforced during the event.

Static Cool Setpoint* (Setup Step 62)

Static Heat Setpoint* (Setup Step 63)

Specifies the setpoints that will come into use during an event when the ADR ACTION is set to OBSERVE STATIC SETPOINTS

Cool Setpoint Offset* (Setup Step 64)

Heat Setpoint Offset* (Setup Step 65)

Specifies how much the current setpoints in effect prior to an event will be altered during an event when the ADR is set to OBSERVE SETPOINT OFFSETS. The heat setpoint can be adjusted by -1 to -15 degrees, cool setpoint by 1 to 15 degrees.

Setup Steps

Press the **SETUP** button, then press **MODE** repeatedly until the desired setup step appears. Use the **WARMER** or **COOLER** buttons to make selection. Press **MODE** to advance to the next step. Press/hold **MODE** to go backwards to prior steps. Press **SETUP** to leave the setup screens.



IAQ Air Patrol (Setup Step 66)

Select whether you want the Air Patrol features to be **ENABLED** or **DISABLED**. You may always view the IAQ value regardless of this setting.

Air Patrol on if IAQ exceeds MODERATE Quality (Setup Step 67)

This setting specifies at which IAQ category that Air Patrol activates, either **MODERATE** or **POOR**. This step only appears if Step #66 is set to **ENABLED**.

Air Patrol Fan on Minutes (Setup Step 68)

When IAQ value meets the level specified in Step #67, the indoor blower will run for the length of time specified in this step, 5 to 60 minutes. This step only appears if step #66 is set to enabled.

Skyport* (Setup Step 69)

Set to **ON** to allow access to Skyport services or to **OFF** to not allow access to Skyport services. Visit venstar.com for more information.

Local API* (Setup Step 70)

Set to **ON** to allow third-party software to interface with your thermostat. Typically used with home automation set-ups.

Show Clock (Setup Step 71)

Select **ON** or **OFF** to have the time of day appear on the screen

Show IAQ (Setup Step 72)

Select **ON** or **OFF** to have IAQ measured levels of **MODERATE** or **POOR** show on the scrolling display.

Press Fan To Clear All Messages (Setup Step 73)

This feature allows the user to clear all current error messages from the display.

Locking the Buttons

Locking/Unlocking the Buttons

To prevent unauthorized use of the thermostat, the front panel buttons may be disabled. To disable, or 'lock' the keypad, press and hold the MODE button. While holding the MODE button, press the WARMER and COOLER buttons together for 5 seconds. The  icon will appear on the display, then release the buttons.

Press all three buttons in the order outlined above for button lockout

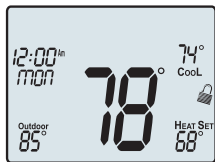

To **unlock** the buttons, press and hold the MODE button. While holding the MODE button, press the WARMER and COOLER buttons together for 5 seconds.

The  icon will disappear from the display, then release the buttons.

Holiday Feature

Holiday

The **Holiday** feature allows the thermostat to use temporary, energy saving settings without having to change regular programming.



Holiday setup/programming at the local thermostat is not allowed. In this case Holiday setup and programming is accomplished with the Skyport Web App. Skyport gives the user extensive control over Holiday settings.

If the **HOLIDAY** button is pressed during an active Holiday period, then the active Holiday period may be cancelled by pressing the **MODE** button.

Calibration

Under normal circumstances it will not be necessary to adjust the calibration of the temperature or humidity sensors. If calibration is required, please contact a trained HVAC technician to correctly perform the following procedure.

1. Press and hold SETUP for 10 seconds.
All icons will appear on the display.

Keep pressing the **SETUP** button until you see this screen.

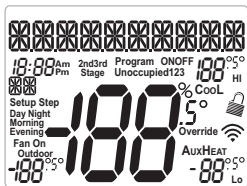

2. After all the icons appear, release SETUP. Press MODE five times until CALIBRATE SENSORS? UP=YES MODE=NEXT appears on the display.
3. Press UP/WARMER to move to thermostat screen, then adjust the indicated room temperature readings as desired, then MODE to store and move to next screen. The offset can be adjusted +/- 7°
4. After the TEMPERATURE screen is the HUMIDITY screen. Adjust the indicated room humidity reading as desired (+/- 15%), then MODE to store and move to next screen.
5. Press MODE to move through the remaining steps and return to normal thermostat operation.

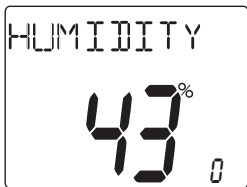

Restoring Factory Default Settings

Resetting the Thermostat to the Factory Default Settings

(for default values see page 46, Advanced Setup Steps Table)

If, for any reason, you desire to return all the stored settings back to the factory default settings, follow the instructions below.

WARNING: This will reset all Time Period and Advanced Programming to the default settings. Any information entered prior to this reset may be permanently lost.

- 1 Press and hold SETUP for 10 seconds.
All icons will appear on the display.

Keep pressing the SETUP button until you see this screen.



- 2 After all the icons appear, release SETUP. Press and hold FAN for 5 seconds. FD ALL will appear on the display. Use WARMER/COOLER to select the range of settings to be cleared and/or reset to factory settings. Press/hold FAN for 2 seconds to bring defaults into your selection. After successfully defaulted, the screen will return to all icons. Press SETUP to return to normal thermostat operation.

The available options are:

- FD STAT: resets all setup steps to the values shown in the table on pages 46-48. The time period schedule is reset
- FD WIFI: all info regarding Wi-Fi access points is erased
- FD SENSORS: all pairing info for VenNet or Wi-Fi sensors is erased
- FD ALL: performs all three functions FD STAT, FD WIFI and FD SENSORS. This effectively returns settings to when the thermostat was new.

Restoring Factory Default Settings

- 3 After the defaults have been restored, the screen will return to all icons. Either press MODE repeatedly or SETUP to return to normal thermostat operation.

Installation Instructions Test Operation

The thermostat has a diagnostic feature that enables testing of all outputs. This feature is contained in the thermostat's **technician setup**.

To enter Technician Setup, press and hold the SETUP button for 10 seconds until all the icons appear. Follow the next steps to view settings and test equipment.

1. Press **MODE** to view the pcb and firmware versions. The firmware version will be numbers like 05-XX-YY.
2. Press **MODE** to view the firmware level and other info from any paired VenNet sensor.
3. Press **MODE** again to view the jumper settings and current state of the Dry Contact terminal.

4. Press **MODE** again and the scrolling display will read **TURN ON EQUIPMENT?** Press **WARMER** for Yes or **COOLER** for No.

If Yes is chosen, press **WARMER** to turn on heat or **COOLER** to turn on Cooling. The scrolling display will read **NOTHING ON**. Next:

Press **WARMER** to turn on and cycle up through the heating stages.

Press **COOLER** to turn the heating stages off. Press **MODE** to exit.

Press **COOLER** to turn on and cycle down through the cooling stages.

Press **WARMER** to turn the cooling stages off. Press **MODE** to exit.

5. Press **MODE** until **CALIBRATE SENSORS?** appears on the scrolling display. Press **WARMER** for Yes or **COOLER** for No. Press **MODE** to select which sensor to calibrate. Use **WARMER** or **COOLER** to modify your selection.
6. Press **MODE** until **CONTROL HUM?** appears on the scrolling display. Press **WARMER** for On or **COOLER** for Off. Press **MODE** to continue.
7. Press **MODE** until **CONTROL DEHUM?** appears on the scrolling display. Press **WARMER** for On or **COOLER** for Off. Press **MODE** to continue.
8. Press **MODE** until **CONTROL AUX OUT?** appears on the scrolling display. Press **WARMER** for On or **COOLER** for Off. Press **MODE** to exit.

To exit Technician Setup at any time, press the SETUP button. Technician Setup will automatically exit after 10 minutes if no buttons are pressed.

Installation Instructions

Remove and Replace the old thermostat

To install the thermostat properly, please follow these step by step instructions. If you are unsure about any of these steps, call a qualified technician for assistance.

- Assemble tools: Flat blade screwdriver, wire cutters, wire strippers and phone camera.
- Make sure your Heater/Air Conditioner is working properly before beginning installation of the thermostat.
- Carefully unpack the thermostat. Save the screws, any brackets, and instructions.
- Turn off the power to the Heating/Air Conditioning system at the main fuse panel. Most residential systems have a separate breaker for disconnecting power to the furnace.
- Remove the cover of the old thermostat. If it does not come off easily, check for screws.
- Loosen the screws holding the thermostat base or subbase to the wall and lift away.
- If you have a smart phone handy, take a photo of the wiring for future reference.
- Disconnect the wires from the old thermostat. Tape the ends of the wires as you disconnect them, and mark them with the letter of the terminal for easy reconnection to the new thermostat.
- Keep the old thermostat for reference purposes, until your new thermostat is functioning properly.

Installation Instructions

Wire Connections

If the terminal designations on your old thermostat do not match those on the new thermostat, **refer to the chart below or the wiring diagrams that follow.**

Wire from the old thermostat terminal marked	Function	Install on the new thermostat connector marked
G or F	Fan	G
Y1, Y	Cooling	Y1
W1, W	Heating	W1
Rh, R, M, Vr, A	Power	R
C	Common	C
W2	2nd Stage Heat	W2
Y2	2nd Stage Cooling	Y2
Y3	3rd Stage Cooling	Y3
Y4	4th Stage Cooling	Y4
H, Hum	Humidity	HUM
D, Dehum	Dehumidity	DEHUM
Ck1	Dry Contact Switch	DRY CONTACT
CKGND	Dry Contact Switch	DRY CONTACT

Installation Instructions

The Explorer IAQ Thermostat Backplate

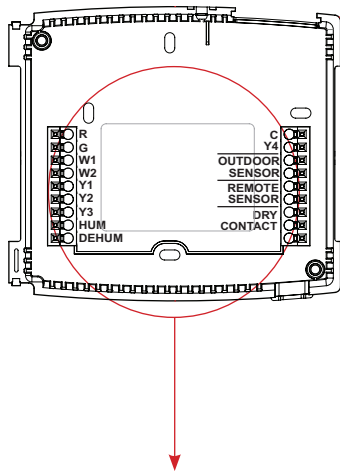

To remove the thermostat backplate:
Gently separate the display from the base by pulling first from one side, then the other until the two pieces unsnap. A small screwdriver may be used, very carefully, to start separating the two pieces.

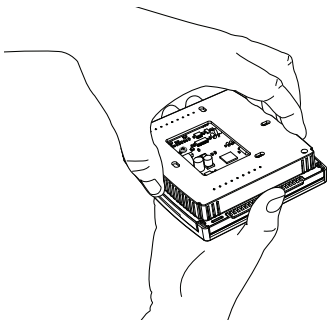

R	24 VAC return	C	24 VAC common
G	Fan relay	Y4	4th stage comp. relay
W1	1st stage heat circuit	OUTDOOR SENSOR	Outdoor sensor connections
W2	2nd stage heat circuit	REMOTE SENSOR	Remote sensor connections
Y1	1st stage compressor relay	DRY CONTACT	Dry Contact connections
Y2	2nd stage compressor relay		
Y3	3rd stage compressor relay		
HUM	Humidifier control circuit		
DEHUM	Dehumidifier control circuit		

IMPORTANT: This thermostat requires both R (24 VAC Return) and C (24 VAC Common) be connected to the backplate terminals.

Installation Instructions

Check Dip Switch

Ensure which switch is correct for your system. Dip switches are located on the back of the thermostat.

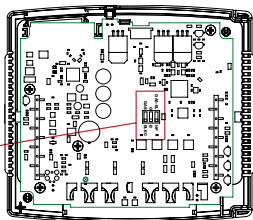
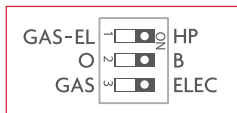

1. This switch (GAS or ELEC) controls how the thermostat will control the Fan (G) terminal in heating mode. When GAS is chosen, the thermostat will not energize the Fan (G) terminal in heating. When ELEC is chosen the thermostat will energize the fan in heating.

NOTE: The other two switches have no function in this model

Installation Instructions

Wiring Diagram

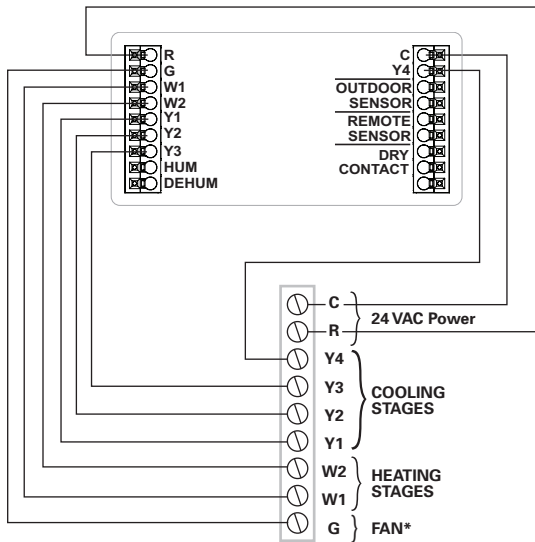

* Set GAS/ELEC dip switch to ELEC position to have fan turn on with a heat demand, as with electric heat systems.

Installation Instructions

Humidification or Dehumidification

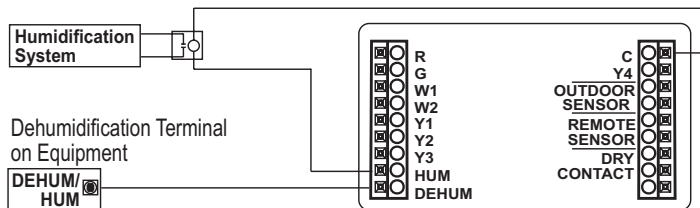

Dry Contact and Aux Output

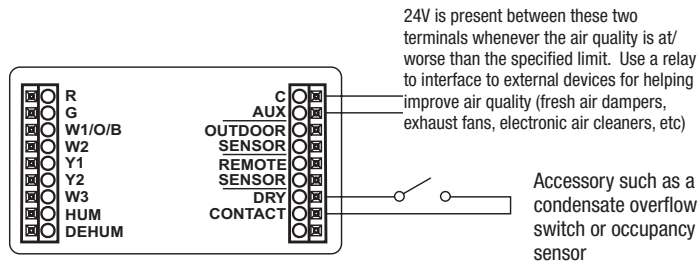

Technician Setup

To enter Technician Setup, press and hold the **SETUP** button for 10 seconds. After all the icons appear, press **MODE**. The version number of the thermostat will appear in the scrolling text. Press **MODE** to advance to the next step. Use the **WARMER** or **COOLER** buttons to adjust the value of your selection. To leave Technician Setup, press **SETUP**.

Hold for 10 seconds



All icons appear



Press **MODE** to advance through the setup steps



Press **WARMER** or **COOLER** to adjust the selection



Technician Setup is for diagnostic and testing purposes and is intended for use by a qualified technician.

Technician Setup contains the following options:

- View the firmware revision of the thermostat.
- View the firmware revision of VenNet.
- View the DIP switch setting of **J1** (Gas/Electric or Heat Pump), **J2** (Reversing Valve: RV=O or RV=B), and **J3** (Fan: Gas or Electric) and state of Dry Contact input
- Turn on equipment outputs for testing.
- Calibrate thermostat, remote, and humidity sensors.
- Control HUM output (On or Off)
- Control DEHUM output (On or Off)
- Control AUX output (On or Off)

Troubleshooting

- **SYMPTOM:** The air conditioning does not attempt to turn on.
CAUSE: The compressor timer lockout may prevent the air conditioner from turning on for a period of time.
REMEDY: You might want to change the Compressor Minimum Off Minutes to 0 in setup step #26.
- **SYMPTOM:** The display is blank.
CAUSE: Lack of proper power.
REMEDY: Make sure the power is on to the furnace and that you have 24vac between **R & C**.
- **SYMPTOM:** The air conditioning does not attempt to turn on.
CAUSE: The cooling setpoint is set too high.
REMEDY: Lower the cooling setpoint or lower the cooling set-point limit.
See Setpoint Limits (page 21).
- **SYMPTOM:** The heating does not attempt to turn on.
CAUSE: The heating setpoint is set too low.
REMEDY: Raise the heating setpoint or raise the heating set-point limit.
See Setpoint Limits (page 21).
- **SYMPTOM:** When the Program button is pressed, the display reads "DISABLED".
CAUSE: Program mode is set to "**NON PROGRAM**".
REMEDY: Set Program Mode (Setup 1) to **7 Day**.
See Selecting Your Program Mode (page 17).

Advanced Setup Table

Df = Factory Default Setting

Step#	Description	Pg#	Range	Df
1	Prog Mode	17	Non, 7 Day	7
2	Available Modes	17	Heat/Cool/Auto/Off, Heat/Cool/Off, Heat/Off, Cool/Off	Heat/Cool/Auto/Off
3	Backlight	18	On, Off	Off
4	Backlight Level	18	Off through 7 levels of brightness	Level 5
5	Night Dimmer	18	On/Off	Off
6	Night Dimmer Brightness	18	Off through 7 levels of brightness	2 (20%)
7	Night Dimmer Start Time	18	12A-12A	8:00P
8	Night Dimmer Stop Time	18	12A-12A	6:00A
9	Current Service Filter Runtime Hours	18	0-1999 Hours	0
10	Current Service Filter Calendar Days	18	0-720 Days	0
11	Current Heat Runtime Hours	19	0-1999 Hours	0
12	Current Aux Heat Runtime Hours	19	0-1999 Hours	0
13	Current Cool Runtime Hours	19	0-1999 Hours	0
14	Current Override Hours	19	0-1999 Hours	0
15	Current UV Lamp Calendar Days	19	0-720 Days	0
16	Current Humidifier Calendar Days	19	0-720 Days	0
17	Set Service Filter Runtime Hours	20	0-1950 hours	0
18	Set Service Filter Calendar Days	20	0-720 Days	0
19	Set UV Lamp Calendar Days	20	0-720 Days	0
20	Set Humidifier Calendar Days	20	0-720 Days	0
21	Language	20	English, Espanol, Francais	English
22	Setpoint Limits	21	0 - 3	0
23	Max Heat Setpoint	21	35 - 99 Degrees	74
24	Min Cool Setpoint	21	35 - 99 Degrees	70
25	Cycles Per Hour	22	No Limit, 2, 3, 4, 5, 6	6
26	Compressor Minimum Off Minutes	22	0,3,5	5
27	Min. Heat/Cool Setpoint Difference	22	0 - 6 Degrees	2
28	1st Stage Deadband	23	1 - 6 Degrees	2

cont. next page

Advanced Setup Table

Df = Factory Default Setting

Step#	Description	Pg#	Range	Df
29	2nd Stage Deadband	23	0 - 10 Degrees	2
30	3rd Stage Deadband	23	0 - 10 Degrees	2
31	4th Stage Deadband	23	0 - 10 Degrees	2
32	Minutes Between 1st and 2nd Stage	23	0 - 60 Minutes	2
33	Minutes Between 2nd and 3rd Stage	23	0 - 60 Minutes	2
34	Minutes Between 3rd and 4th Stage	23	0 - 60 Minutes	2
35	2nd Stage Turnoff Point	24	Deadband, Setpoint	Deadband
36	3rd Stage Turnoff Point	24	Deadband, Setpoint	Deadband
37	4th Stage Turnoff Point	24	Deadband, Setpoint	Deadband
38	Minutes of Fan Purge	24	0 - 3:00, 15 min. increments - 0 = off	0
39	Wired Sensor Type	25	Remote, Supply, Return	Remote
40	Control to Temp Source	25	Thermostat, Wired Remote*, Wireless Remote, Average of Wireless Remotes, Average Thermostat and Wired Remote*, Average All Sensors. *Option only if prior step = "Remote"	Thermostat
41	Wireless Remote to Use	25	list of wifi sensors currently linked to thermostat. * This step only appears if prior step = "Wireless Remote"	first linked sensor in list
42	Humidity Only With Heat	26	On, Off	Off
43	Fan With Humidify	26	Fan On, Fan Off	Fan Off
44	Fan With Dehumidify	26	Fan On, Fan Off	Fan Off
45	Cool To Dehumidify	26	On, Off	Off
46	Maximum Occ Dehum Overcool	26	0 - 20 Degrees	2
47	Maximum Unocc Dehum Overcool	26	0 - 20 Degrees	2
48	Fan Off Delay	26	0 - 120 Seconds	0
49	F/C	27	Fahrenheit (F), Celsius ©	F
50	Smart Recovery	27	On, Off	Off
51	Dry Contact Polarity	28	Open, Closed	Open
52	Dry Contact Use	28	Occupied, Condensate Pan, FDD, Holiday, Door Switch	Occupied

Advanced Setup Table

Df = Factory Default Setting

Step#	Description	Pg#	Range	Df
53	Humidity Polarity	29	Open, Closed	Open
54	Dehumidify Polarity	29	Open, Closed	Open
55	Dehumidify only with Cooling	29	On, Off	On
56	Light Activation Sensitivity	29	Press Fan button to set current light level	
57	Light Activation to Occupied	29	On/Off	Off
58	ADR	30	On, Off	On
59	ADR Action	30	Observe Setpoint Offsets, Observe Static Setpoints	Observe SP Offsets
60	Event Max Cool Setpoint	31	65 - 90	90
61	Event Min Heat Setpoint	31	50 - 85	50
62	Static Cool Setpoint	31	65 - 85	82
63	Static Heat Setpoint	31	65 - 85	60
64	Cool Setpoint Offset	31	1 to 15	4
65	Heat Setpoint Offset	31	-1 to -15	-4
66	IAQ Air Patrol	32	enabled, disabled	disabled
67	Air Patrol On If IAQ Exceeds MODERATE Quality	32	Moderate, Poor	Moderate
68	AIR PATROL FAN ON MINUTES	32	5 - 60	10
69	Skyport	32	On, Off	On
70	Local API	32	On, Off	Off
71	Show Clock	32	On, Off	On
72	Show IAQ	32	On, Off	Off
72	Press Fan To Clear All Messages	32		

Warranty

One-Year Warranty - This Product is warranted to be free from defects in material and workmanship. If it appears within one year from the date of original installation, whether or not actual use begins on that date, that the product does not meet this warranty, a new or remanufactured part, at the manufacturer's sole option to replace any defective part, will be provided without charge for the part itself provided the defective part is returned to the distributor through a qualified servicing dealer.

THIS WARRANTY DOES NOT INCLUDE LABOR OR OTHER COSTS incurred for diagnosing, repairing, removing, installing, shipping, servicing or handling of either defective parts or replacement parts. Such costs may be covered by a separate warranty provided by the installer.

THIS WARRANTY APPLIES ONLY TO PRODUCTS IN THEIR ORIGINAL INSTALLATION LOCATION AND BECOMES VOID UPON REINSTALLATION.

LIMITATIONS OF WARRANTIES – ALL IMPLIED WARRANTIES (INCLUDING IMPLIED WARRANTIES OF FITNESS FOR A PARTICULAR PURPOSE AND MERCHANTABILITY) ARE HEREBY LIMITED IN DURATION TO THE PERIOD FOR WHICH THE LIMITED WARRANTY IS GIVEN. SOME STATES DO NOT ALLOW LIMITATIONS ON HOW LONG AN IMPLIED WARRANTY LASTS, SO THE ABOVE MAY NOT APPLY TO YOU. THE EXPRESSED WARRANTIES MADE IN THIS WARRANTY ARE EXCLUSIVE AND MAY NOT BE ALTERED, ENLARGED, OR CHANGED BY ANY DISTRIBUTOR, DEALER, OR OTHER PERSON WHATSOEVER.

ALL WORK UNDER THE TERMS OF THIS WARRANTY SHALL BE PERFORMED DURING NORMAL WORKING HOURS. ALL REPLACEMENT PARTS, WHETHER NEW OR REMANUFACTURED, ASSUME AS THEIR WARRANTY PERIOD ONLY THE REMAINING TIME PERIOD OF THIS WARRANTY.

THE MANUFACTURER WILL NOT BE RESPONSIBLE FOR:

1. Normal maintenance as outlined in the installation and servicing instructions or owner's manual, including filter cleaning and/or replacement and lubrication.
2. Damage or repairs required as a consequence of faulty installation, misapplication, abuse, improper servicing, unauthorized alteration or improper operation.
3. Failure to start due to voltage conditions, blown fuses, open circuit breakers or other damages due to the inadequacy or interruption of electrical service.
4. Damage as a result of floods, winds, fires, lightning, accidents, corrosive environments or other conditions beyond the control of the Manufacturer.
5. Parts not supplied or designated by the Manufacturer, or damages resulting from their use.
6. Manufacturer products installed outside the continental U.S.A., Alaska, Hawaii, and Canada.
7. Electricity or fuel costs or increases in electricity or fuel costs for any reason whatsoever including additional or unusual use of supplemental electric heat.
8. ANY SPECIAL INDIRECT OR CONSEQUENTIAL PROPERTY OR COMMERCIAL DAMAGE OF ANY NATURE WHATSOEVER. Some states do not allow the exclusion of incidental or consequential damages, so the above may not apply to you.

This warranty gives you specific legal rights and you may also have other rights which may vary from state to state.

Patent Pending

P/N 88-1449 Rev. 2 01/18/22

VENSTAR®